

There are two main types of springs

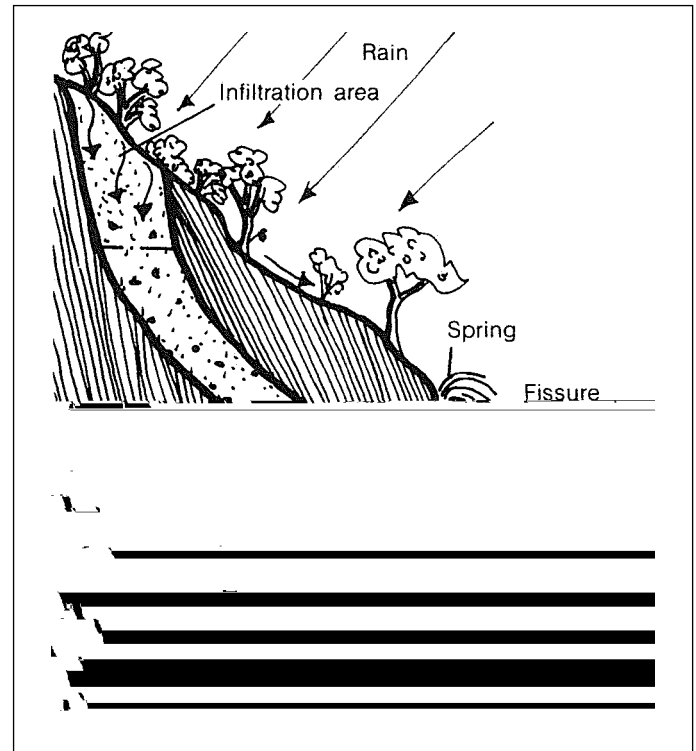

Selecting a spring

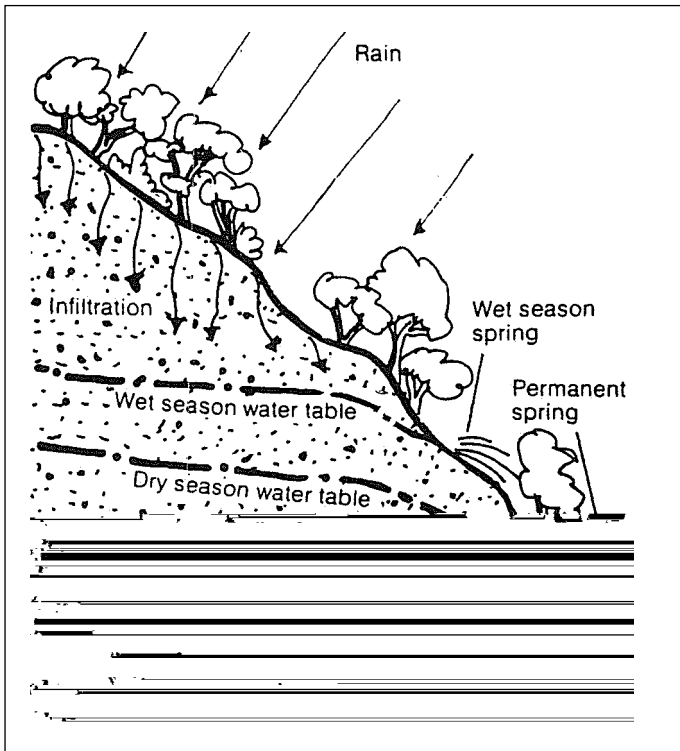
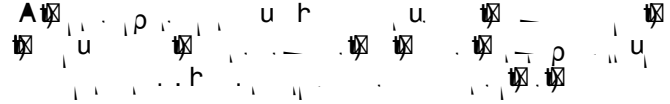
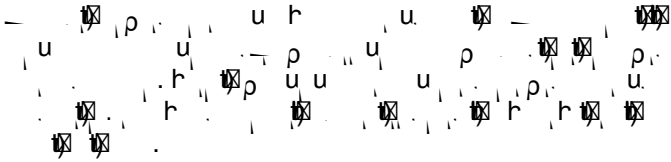
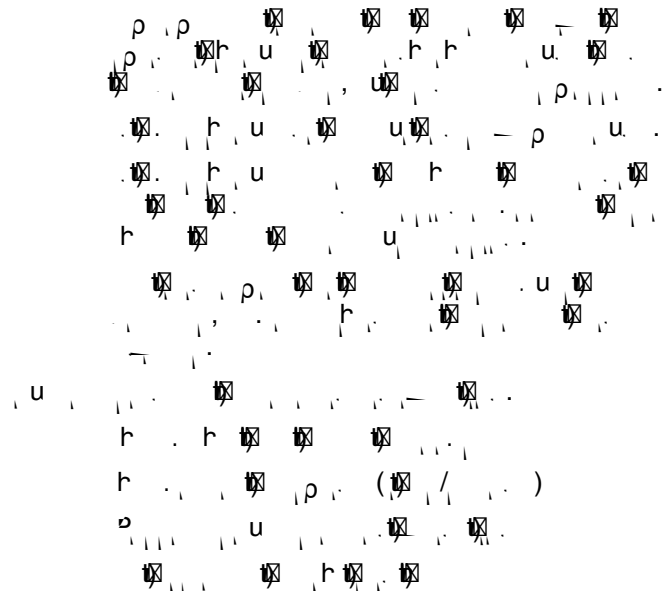
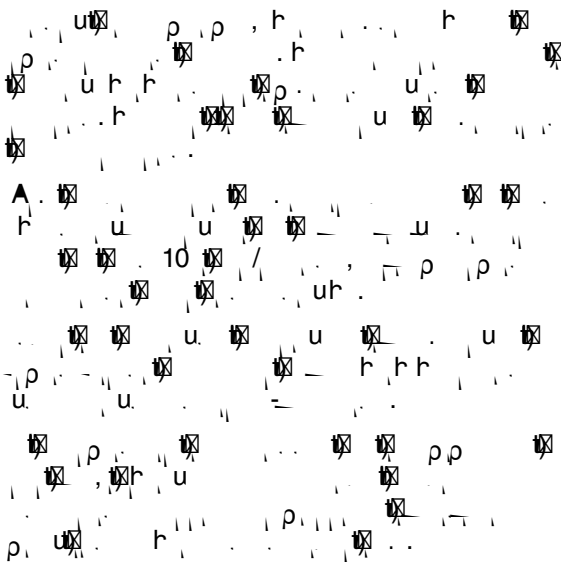

Each spring is, of course, a special case, but building an intake box is one method of protecting a spring from contamination.

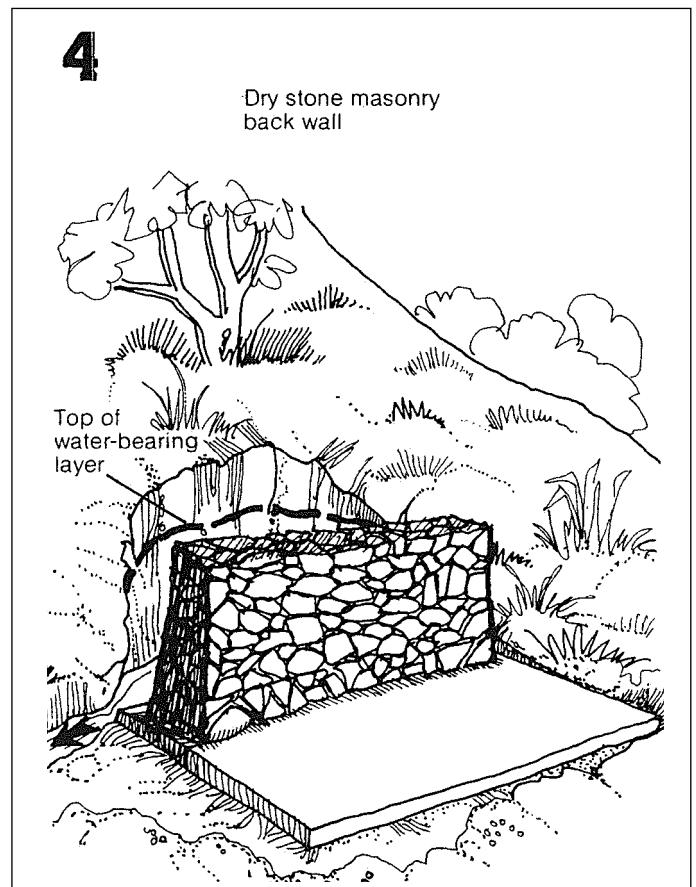
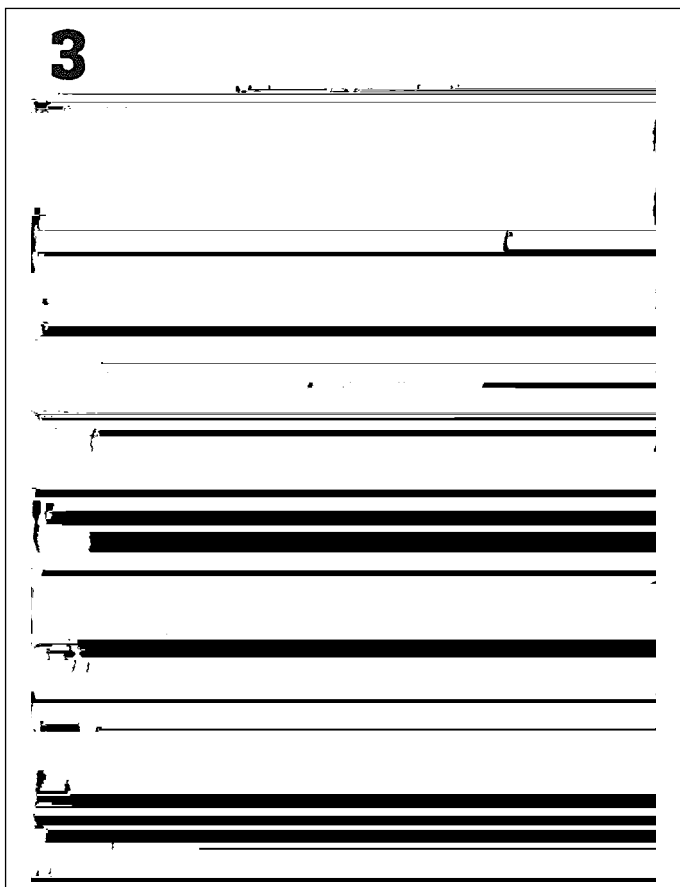
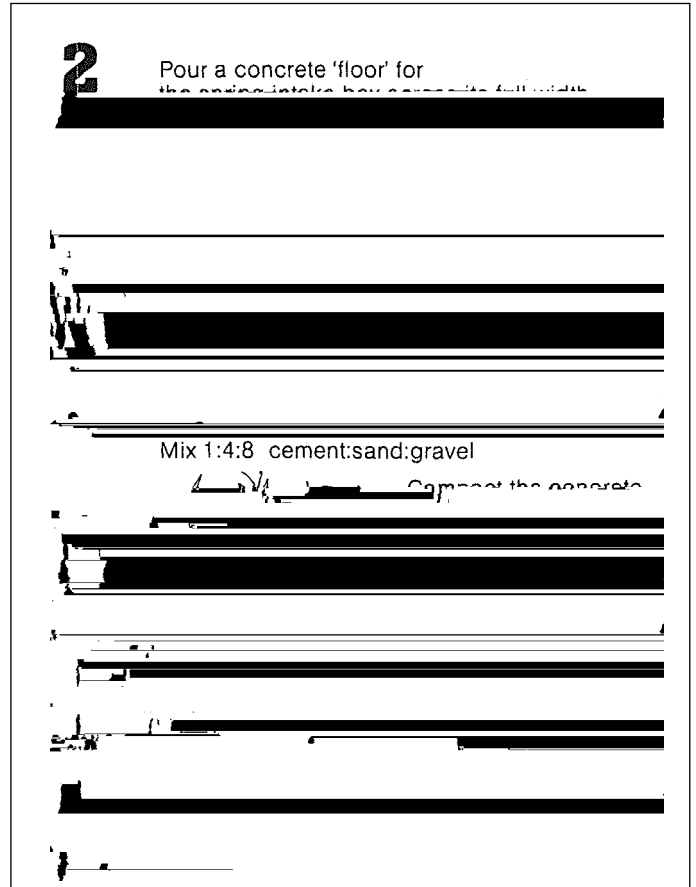
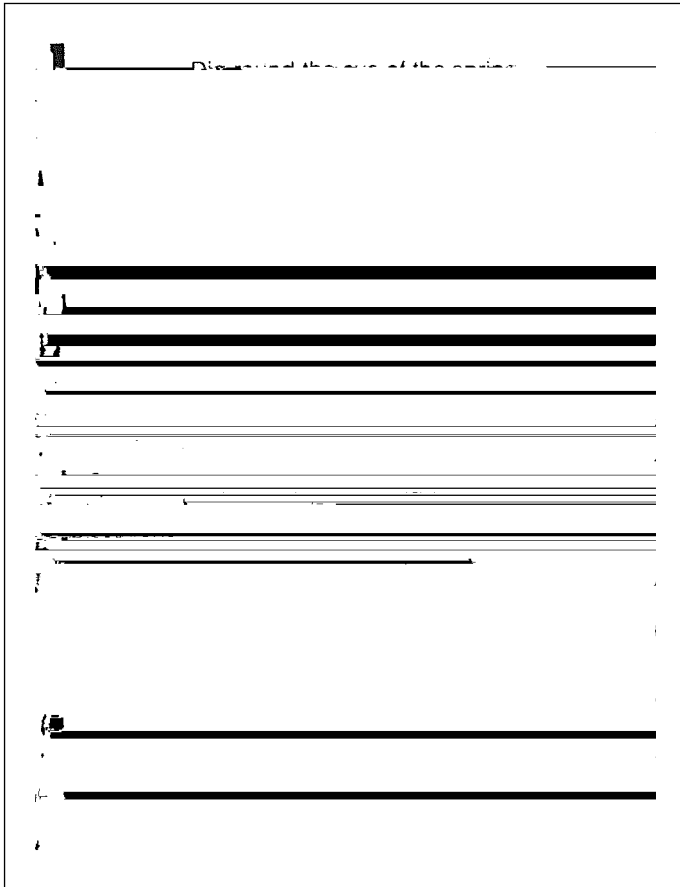

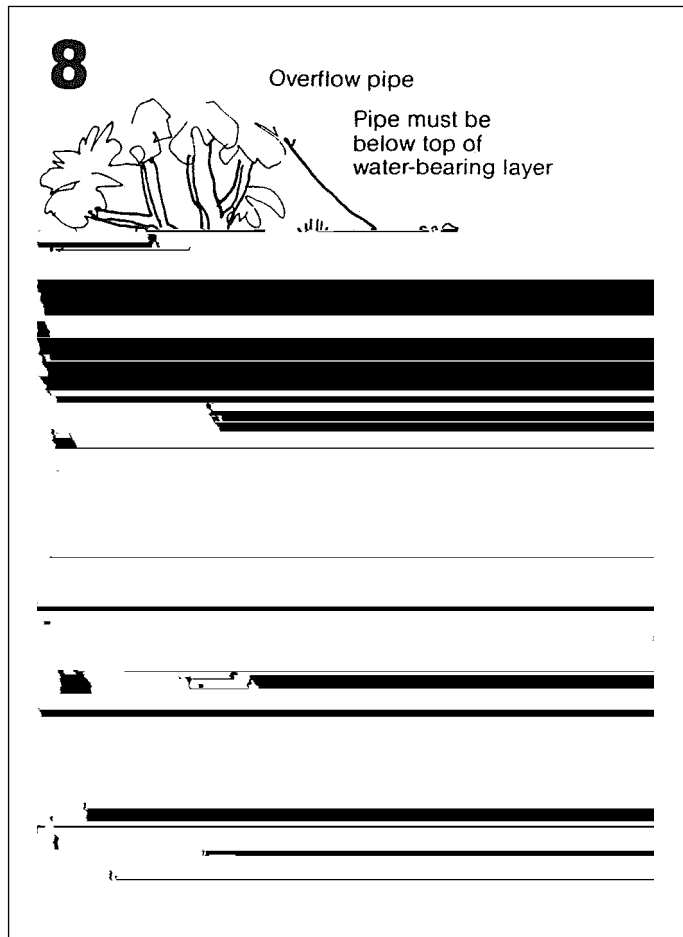
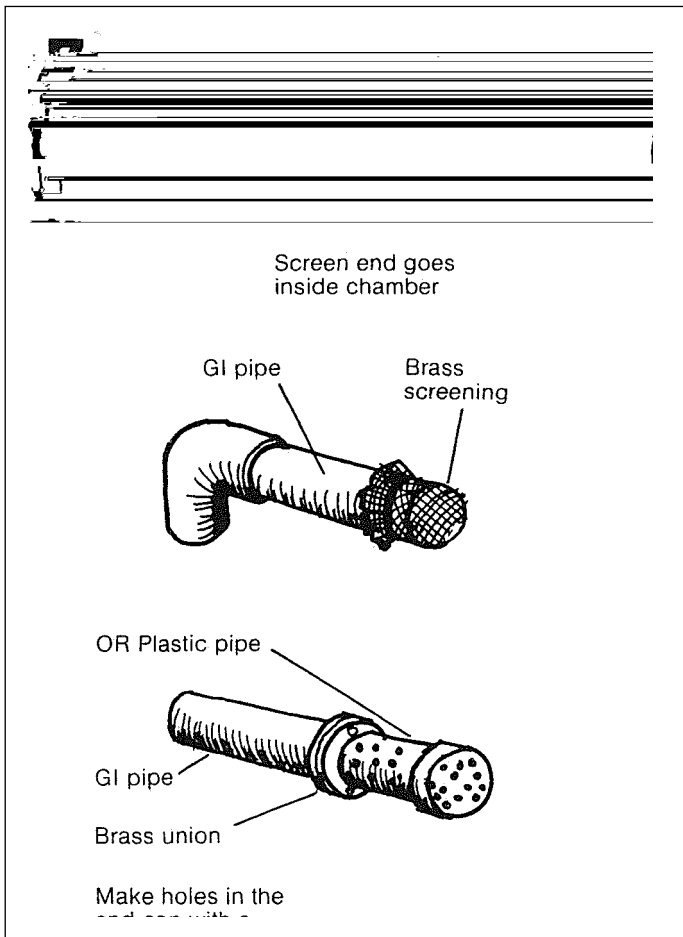
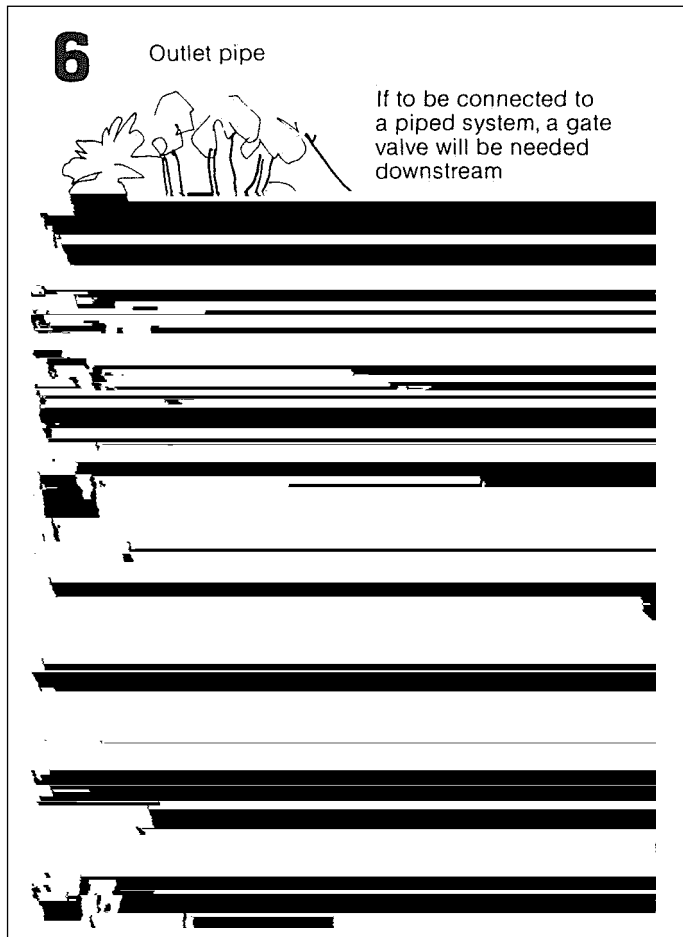
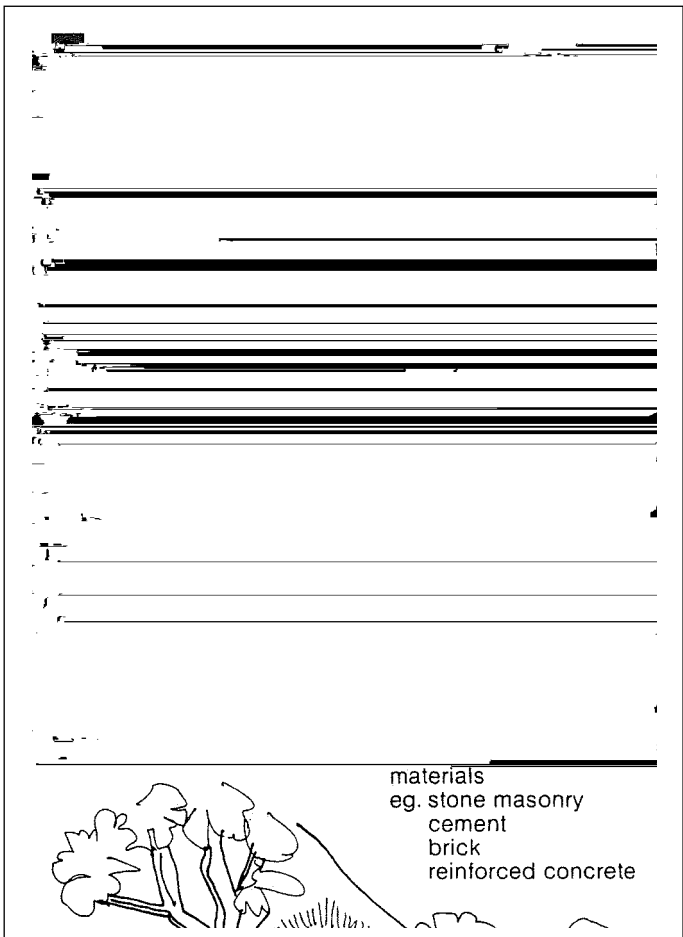

9

Reinforced concrete cover slab

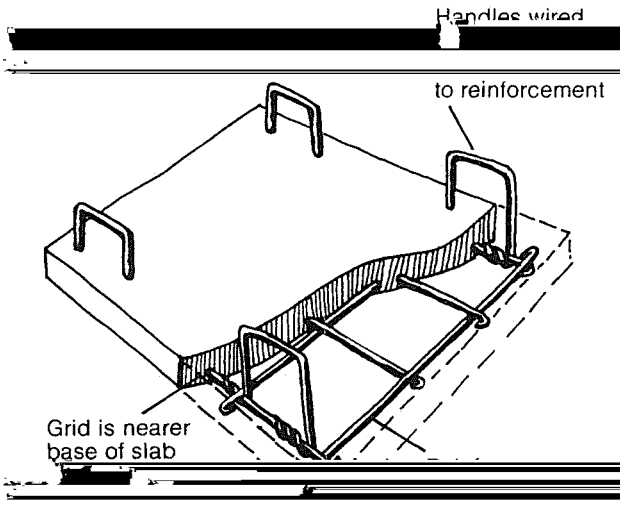

10

Diagram of reinforcement for cover

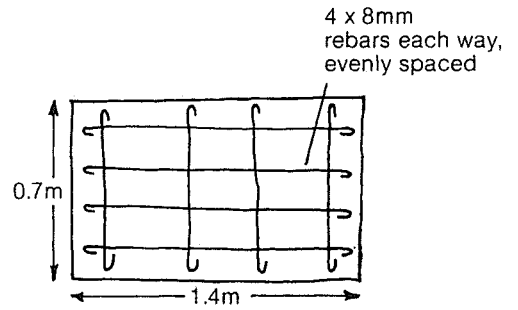

OR use corrugated galvanized steel (CGS) roofing sheets

Tie rebar with wire at crossing points

11



Cover spring box - clean and disinfect first

Gravel or sand

Seal with clay

